

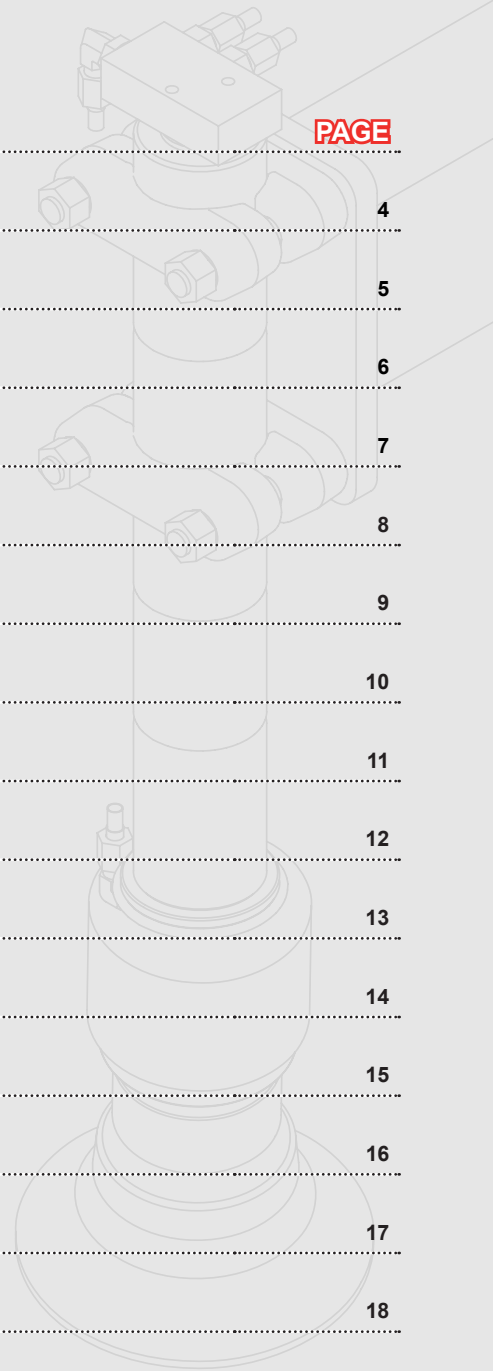

INDEX

SUPPLEMENTARY OUTRIGGERS

	PAGE
60801F - 61801F/CE	4
60802ME - 60802ME/CE	5
210801F	6
210802ME - 210802ME/CE	7
210803ME - 210803ME/CE	8
211801F/CE	9
215800HE - 215800HE/CE	10
290800HE - 290800HE/CE	11
330802HE - 330802HE/CE	12
391800HE	13
415800HE - 415800HE/CE	14
415802HE - 415802HE/CE	15
541800HE - 541800HE/CE	16
700802HE - 700802HE/CE	17
751801HE - 751801HE/CE	18
751802HE - 751802HE/CE	19
1400A140 - 1400A140/CE	20
1400A203 - 1400A203/CE	21
1400A303 - 1400A303/CE	22
1950A203/CE	23



	61801F	60802ME	210801F	210802ME	210803ME	211801F	215800HE	290800HE	330802HE	391800HE	415800HE	415802HE	541800HE	700802HE	751801HE	751802HE	1400A140	1400A203	1400A303	1950A203
F22A active	•	•																		
F28A active	•	•																		
F30CY active	•	•																		
F38A active	•	•																		
F40A active	•	•																		
F50A active / e-active	•	•																		
F55A e-active	•	•																		
F65A active / e-active	•	•																		
F70A e-active	•	•																		
F80A active / e-active	•	•																		
F90A e-active	•	•																		
F95A active / e-active			•	•	•	•														
F105A e-active			•	•	•	•														
F110A active / e-active			•	•	•	•		•												
F120A e-active			•	•	•	•		•												
F135A active / e-active			•	•	•	•		•												
F135A dynamic / e-dynamic			•	•	•	•		•												
S serie			•	•	•	•														
F155A active / e-active			•	•	•	•		•												
F155A dynamic / e-dynamic			•	•	•	•		•												
F165A active / e-active			•	•	•	•		•												
F165A dynamic / e-dynamic			•	•	•	•		•												
F175A active / e-active			•	•	•	•		•												
F175A dynamic / e-dynamic			•	•	•	•		•												
F195A active / e-active			•	•	•	•		•												
F195A dynamic / e-dynamic			•	•	•	•		•												
F215A active / e-active			•	•	•	•	•	•			•									
F215A dynamic / e-dynamic			•	•	•	•	•	•			•									
F235A e-active			•	•	•	•	•	•			•									
F235A e-dynamic			•	•	•	•	•	•			•									
F245A active / e-active			•	•	•	•	•	•			•									
F245A e-dynamic			•	•	•	•	•	•			•									
F275A e-active			•	•	•	•	•	•			•									
F275A e-dynamic			•	•	•	•	•	•			•									
F295A e-dynamic			•	•	•	•	•	•			•									
F295RA e-dynamic			•	•	•	•	•	•			•									
F315A e-dynamic			•	•	•	•	•	•			•									
F315RA e-dynamic			•	•	•	•	•	•			•									
F335A e-dynamic			•	•	•	•	•	•	•		•		•							
F335RA e-dynamic			•	•	•	•	•	•	•		•		•							
F365A e-dynamic			•	•	•	•	•	•	•		•		•							
F365RA e-dynamic			•	•	•	•	•	•	•		•		•							
F385A e-dynamic			•	•	•	•	•	•	•		•		•							
F385RA e-dynamic			•	•	•	•	•	•	•		•		•							
F390SE										•										
F415A e-dynamic			•	•	•	•	•	•	•		•		•							
F415RA e-dynamic			•	•	•	•	•	•	•		•		•							
F425A e-dynamic			•	•	•	•	•	•	•		•		•							
F425RA e-dynamic			•	•	•	•	•	•	•		•		•							
F455A e-dynamic			•	•	•	•	•	•	•		•		•							
F455RA e-dynamic			•	•	•	•	•	•	•		•		•							
F510RA he-dynamic									•											
F560RA he-dynamic									•											
F600RA he-dynamic											•	•								
F660RA he-dynamic											•	•								
F700RA he-dynamic													•	•	•					
F800RA he-dynamic													•	•	•					
F950RA he-dynamic													•				•			
F1100RA he-dynamic													•				•			
F1300RA he-dynamic																	•			
F1500RA he-dynamic																	•	•	•	
F1950RA he-dynamic																	•	•	•	•

60801F - 61801F/CE

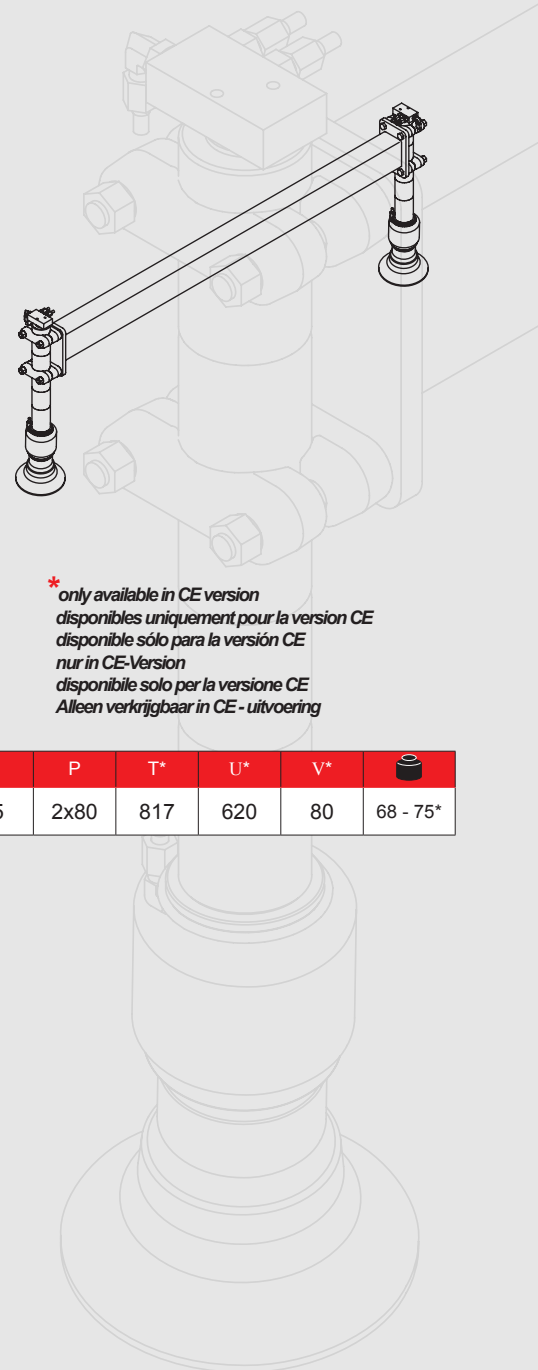
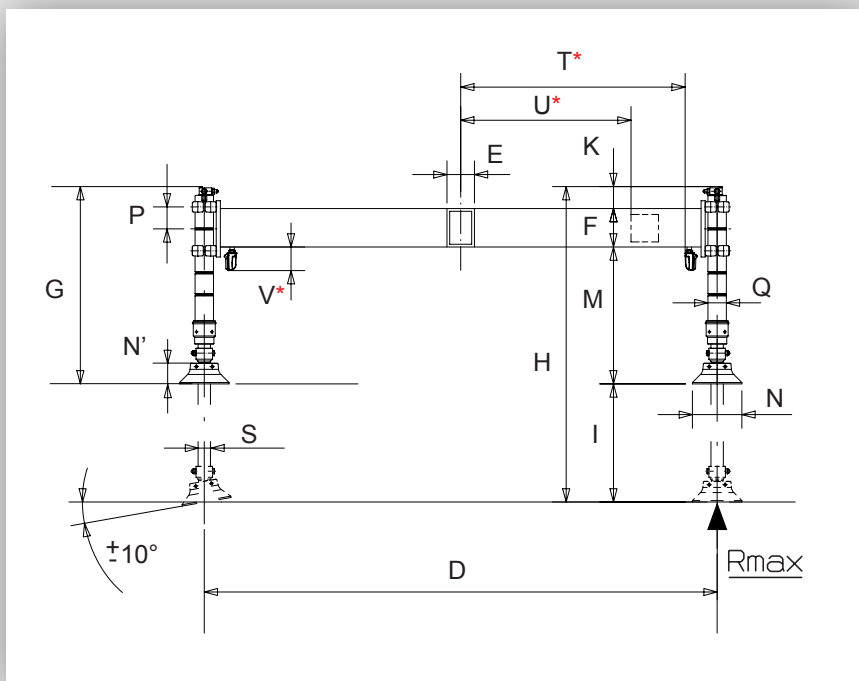

* only available in CE version
 disponibles uniquement pour la version CE
 disponible sólo para la versión CE
 nur in CE-Version
 disponibile solo per la versione CE
 Alleen verkrijgbaar in CE - uitvoering

D	E	F	G	H	I	K	M	N	N'	Q	S	P	T*	U*	V*	
1867	90	115	719	1149	430	97 257	507 347	180	75	67 55	45	2x80	817	620	80	68 - 75*

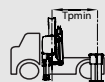

F22A.0 - F40A.0 2000 mm

F50A.0 * - F55A.0 * 2500 mm

F65A.0 * - F70A.0 * 3000 mm

F80A.0 * - F90A.0 * 3500 mm

1580 daN



SUPPLEMENTARY OUTRIGGERS

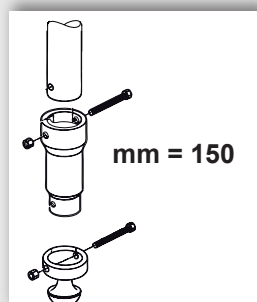
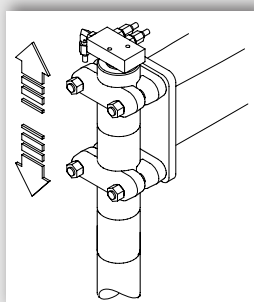

60802ME - 60802ME/CE

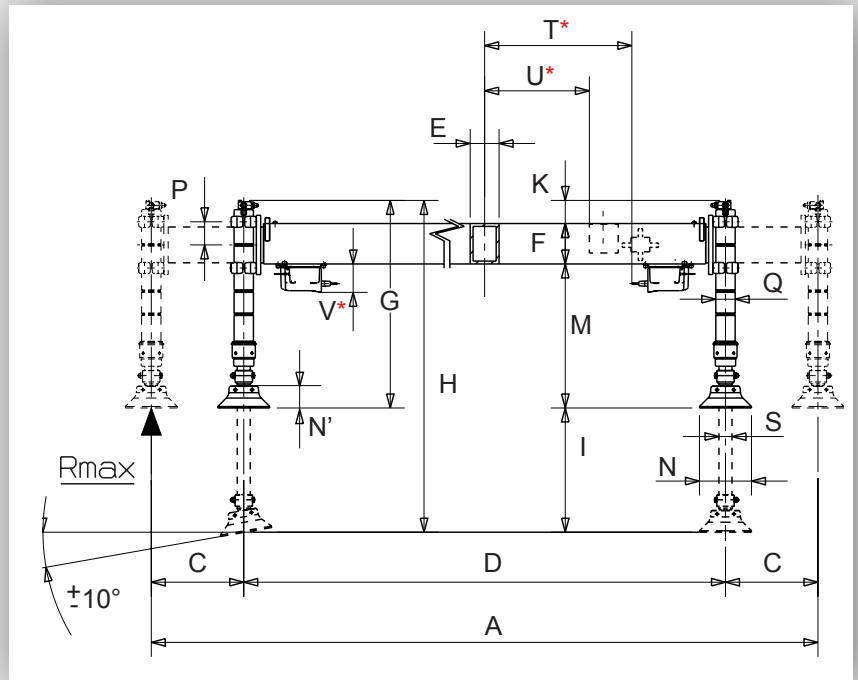
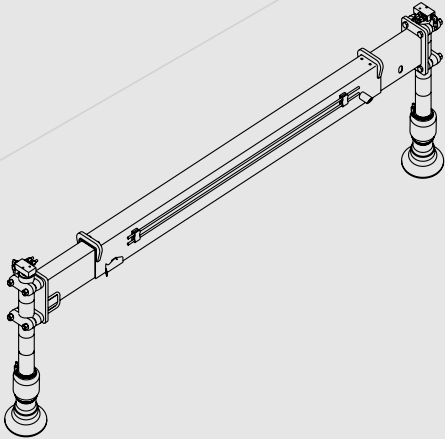

* only available in CE version
 disponibles uniquement pour la version CE
 disponible sólo para la versión CE
 nur in CE-Version
 disponibile solo per la versione CE
 Alleen verkrijgbaar in CE - uitvoering

A	C	D	E	F	G	H	I	K	M	N	N'	Q	S	P	T*	U*	V*	
2507	320	1867	100	140	718	1148	430	80 240	498 338	180	75	67 55	45	2x80	610	463	98	85

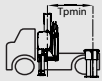

F22A.0 - F40A.0	2000 mm
F50A.0 - F55A.0	2500 mm
F65A.0 - F70A.0	2750 mm
F80A.0 - F90A.0	3600 mm



1380 daN

SUPPLEMENTARY OUTRIGGERS

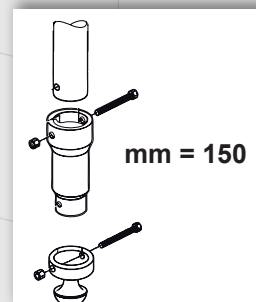
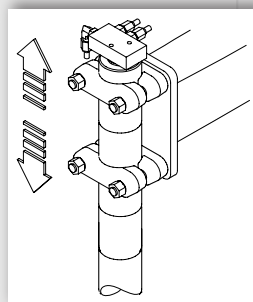
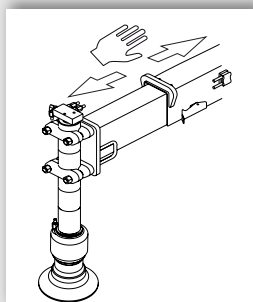

210801F

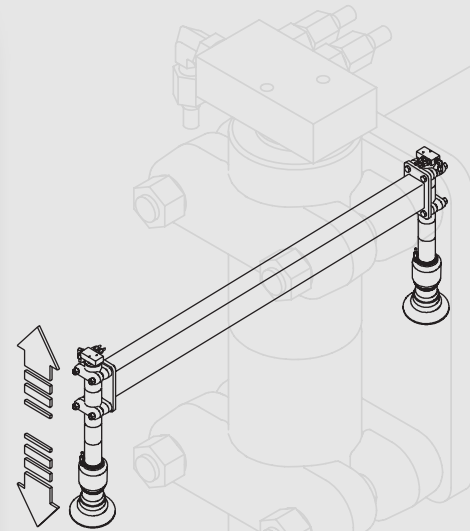
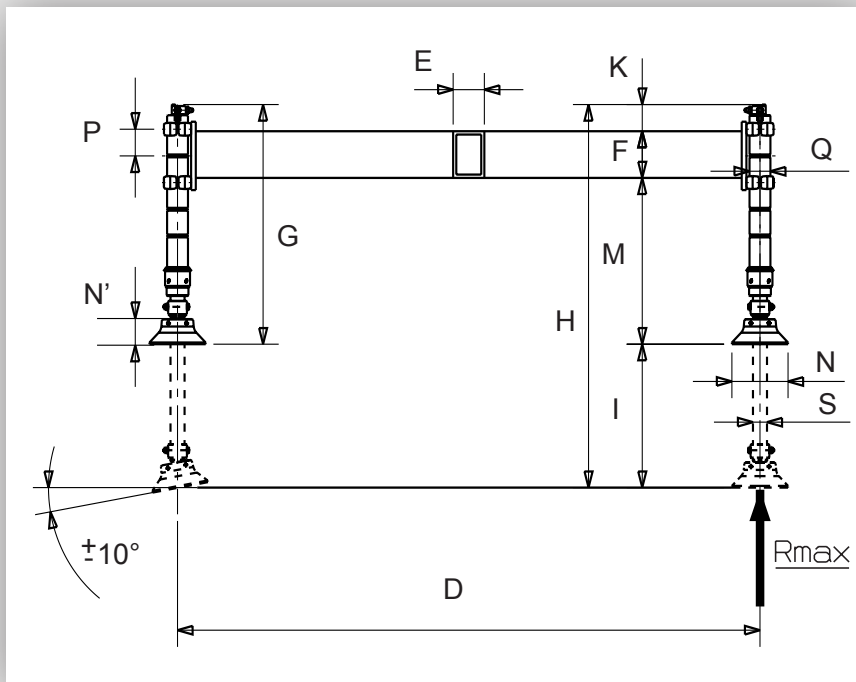

* only available in CE version
 disponibles uniquement pour la version CE
 disponible sólo para la versión CE
 nur in CE-Version
 disponibile solo per la versione CE
 Alleen verkrijgbaar in CE - uitvoering

OPTIONS	D	E	F	G	H	I	K	M	N	N'	Q	S	P	
	2137	105	150	780	1235	455	132	498	180	75	87	60	2x97	116
							327	303			75			
R	2377	105	150	780	1235	455	132	498	180	75	87	60	2x97	149
							327	303			75			
R L	2377	105	150	820	1380	560	102	633	180	75	87	60	3x97	156
							394	342			75			
L	2137	105	150	820	1380	560	102	633	180	75	87	60	3x97	123
							394	342			75			

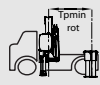
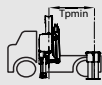

F95A.0 - F165A.2	3000 mm	3300 mm
F175A.0 - F195A.2	3700 mm	4000 mm
F215A.0 - F235A.2	4000 mm	4200 mm
F145AS - F160ASXP	3500 mm	
F185BS - F210BSXP	4000 mm	
F215AS - F240ASXP	4500 mm	

4210 daN 3490 daN



SUPPLEMENTARY OUTRIGGERS

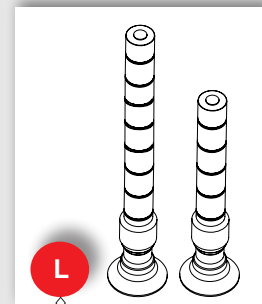
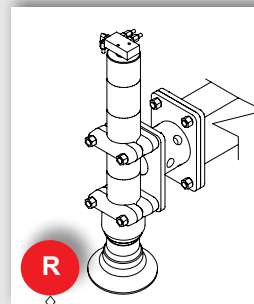
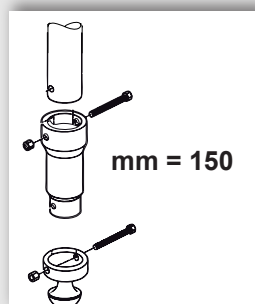
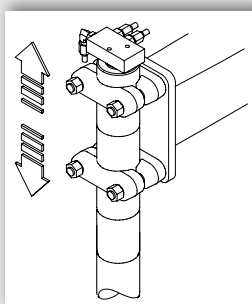

optional

210802ME - 210802ME/CE

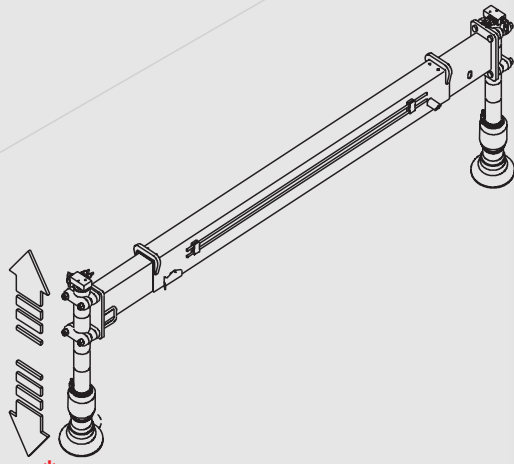

* only available in CE version
 disponibles uniquement pour la version CE
 disponible sólo para la versión CE
 nur in CE-Version
 disponibile solo per la versione CE
 Alleen verkrijgbaar in CE - uitvoering

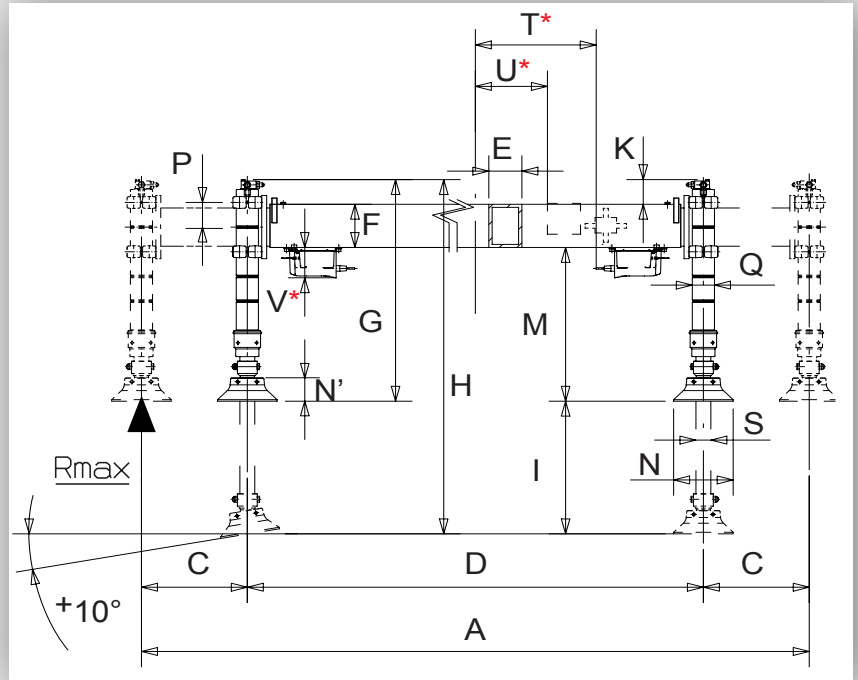

OPTIONS	A	C	D	E	F	G	H	I	K	M	N	N'	Q	S	P	T*	U*	V*	
	3563	700	2163	122	177	780	1235	455	116 311	487 292	180	75	87 75	60	2x97	745	597	98	165
R	3853	700	2453	122	177	780	1235	455	116 311	487 292	180	75	87 75	60	2x97	745	597	98	198
R L	3853	700	2453	122	177	885	1445	560	85 378	622 330	180	75	87 75	60	3x97	745	597	98	205
L	3563	700	2163	122	177	885	1445	560	85 378	622 330	180	75	87 75	60	3x97	745	597	98	173

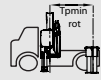
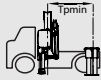

F95A.0 - F110A.0	3000 mm	3000 mm
F135A.0 - F165A.2	3200 mm	3200 mm
F175A.0	3500 mm	3500 mm
F175A.2 - F195A.2	4000 mm	4000 mm
F215A.0 - F235A.2	4200 mm	4200 mm
F145AS - F160ASXP	4000 mm	
F185BS - F210BSXP	4500 mm	
F215AS - F240ASXP	5000 mm	



3430 daN

3100 daN

SUPPLEMENTARY OUTRIGGERS

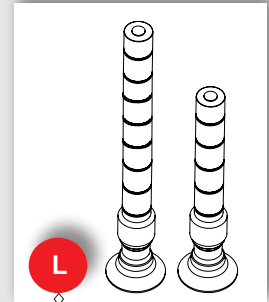
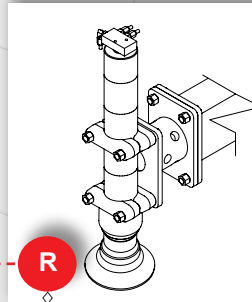
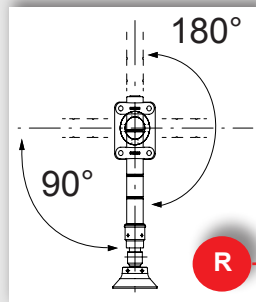
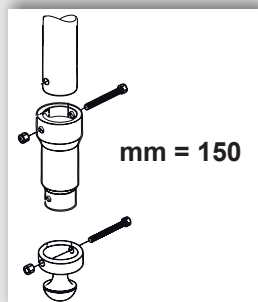
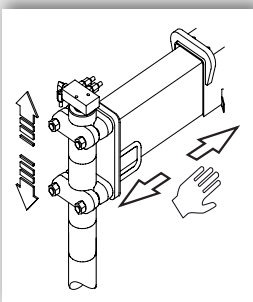

optional

210803ME - 210803ME/CE

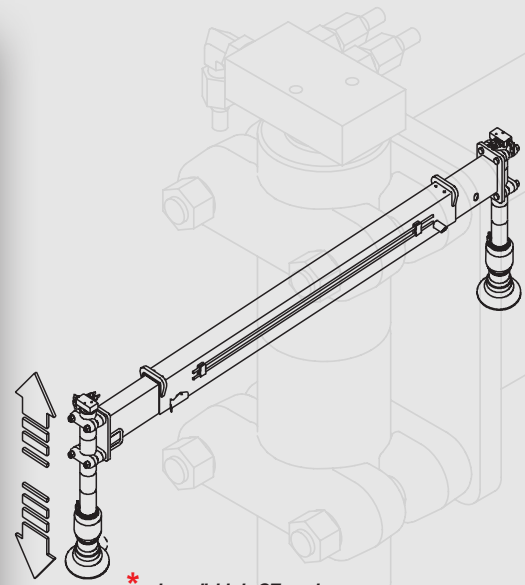
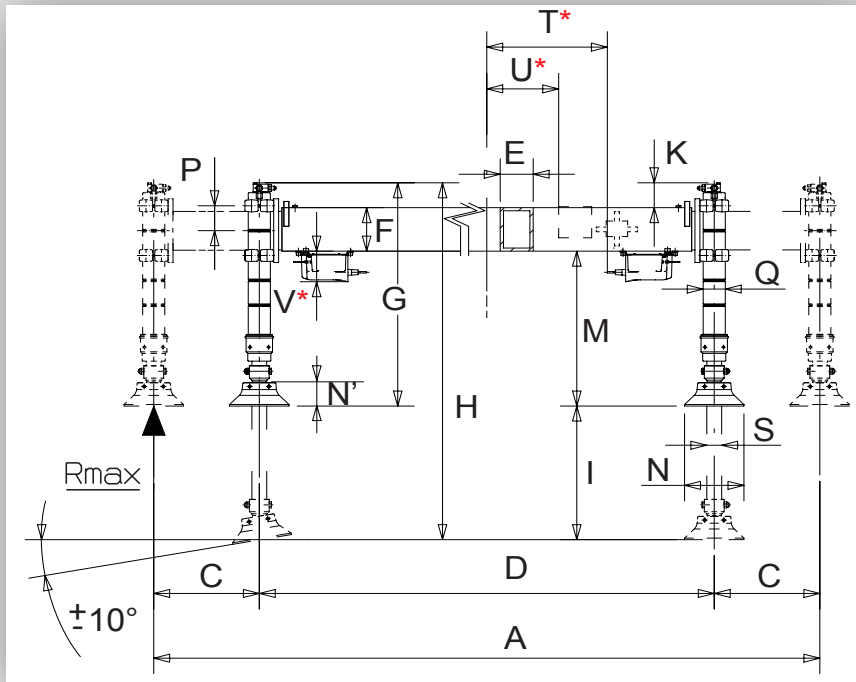

* only available in CE version
 disponibles uniquement pour la version CE
 disponible sólo para la versión CE
 nur in CE-Version
 disponibile solo per la versione CE
 Alleen verkrijgbaar in CE - uitvoering

OPTIONS	A	C	D	E	F	G	H	I	K	M	N	N'	Q	S	P	T*	U*	V*	
	3103	535	2033	122	167	780	1235	455	120 315	492 297	180	75	87 75	60	2x97	679	532	98	153
R	3393	535	2323	122	167	780	1235	455	120 315	492 297	180	75	87 75	60	2x97	679	532	98	190
R L	3393	535	2323	122	167	885	1445	560	85 378	627 334	180	75	87 75	60	3x97	679	532	98	196
L	3103	535	2033	122	167	885	1445	560	85 378	627 334	180	75	87 75	60	3x97	679	532	98	163

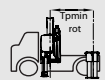
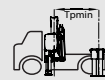

F95A.0 - F120A.0	3000 mm	3300 mm
F135A.0 - F165A.2	3200 mm	3200 mm
F175A.0 - F195A.0	3500 mm	3500 mm
F195A.2 - F235A.2	4000 mm	4000 mm
F145AS - F160ASXP	3500 mm	
F185BS - F210BSXP	4000 mm	
F215AS - F240ASXP	4500 mm	

Rmax std	3770 daN
Rmax rot	3360 daN

SUPPLEMENTARY OUTRIGGERS

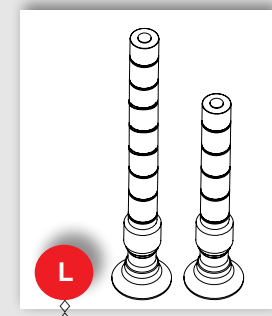
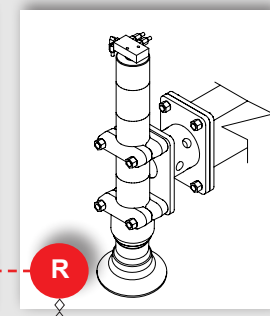
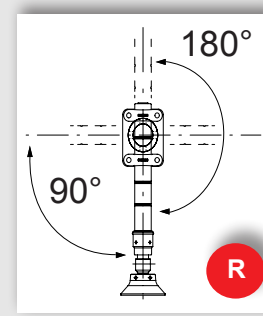
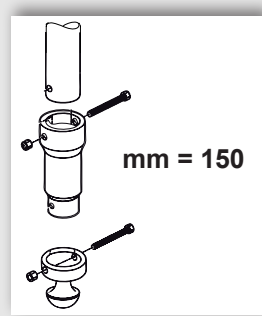
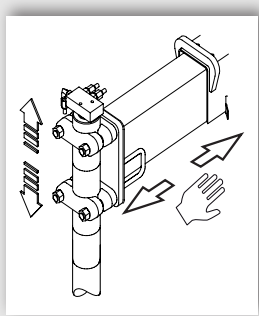

optional

211801F/CE

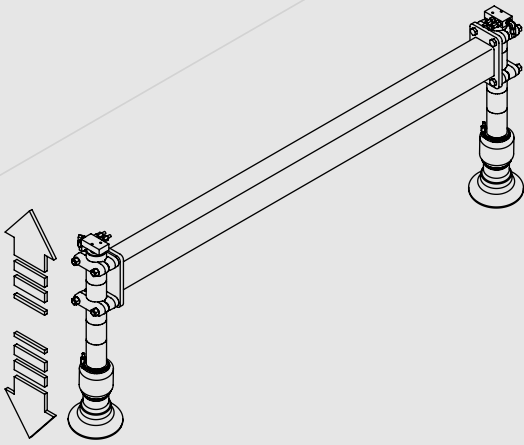

* only available in CE version
 disponibles uniquement pour la version CE
 disponible sólo para la versión CE
 nur in CE-Version
 disponibile solo per la versione CE
 Alleen verkrijgbaar in CE-uitvoering

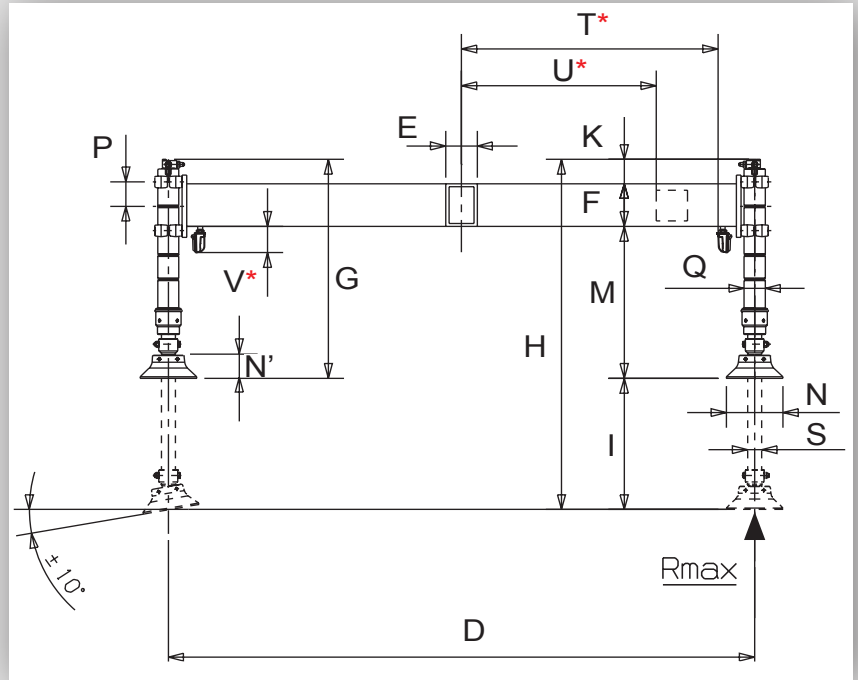

OPTIONS	D	E	F	G	H	I	K	M	N	N'	Q	S	P	T*	U*	V*	
	2137	105	150	780	1235	455	132 327	498 303	180	75	87 75	60	2x97	745	937	80	126
R	2427	105	150	780	1235	455	132 327	498 303	180	75	87 75	60	2x97	745	937	80	159
R L	2427	105	150	820	1380	560	102 394	633 342	180	75	87 75	60	3x97	745	937	80	166
L	2137	105	150	820	1380	560	102 394	633 342	180	75	87 75	60	3x97	745	937	80	133

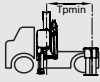

F95A.0 - F165A.2	3000 mm	3300 mm
F175A.0 - F195A.2	3700 mm	4000 mm
F215A.0 - F235A.2	4000 mm	4200 mm
F145AS - F160ASXP	3500 mm	
F185BS - F210BSXP	4000 mm	
F215AS - F240ASXP	4500 mm	

4210 daN

3490 daN

SUPPLEMENTARY OUTRIGGERS

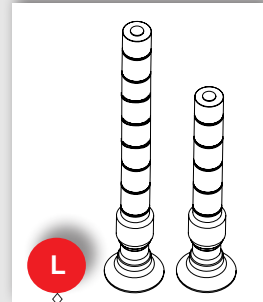
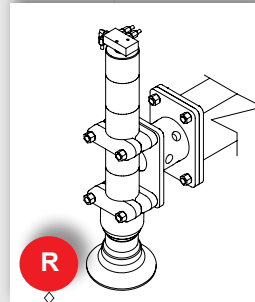
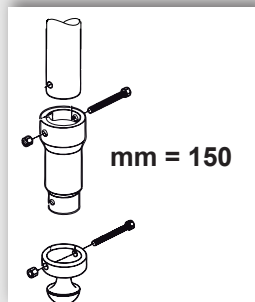
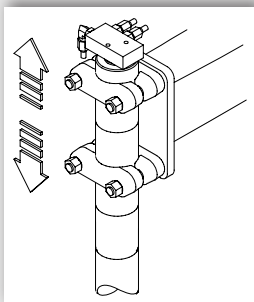

optional

215300HE - 215300HE/CE

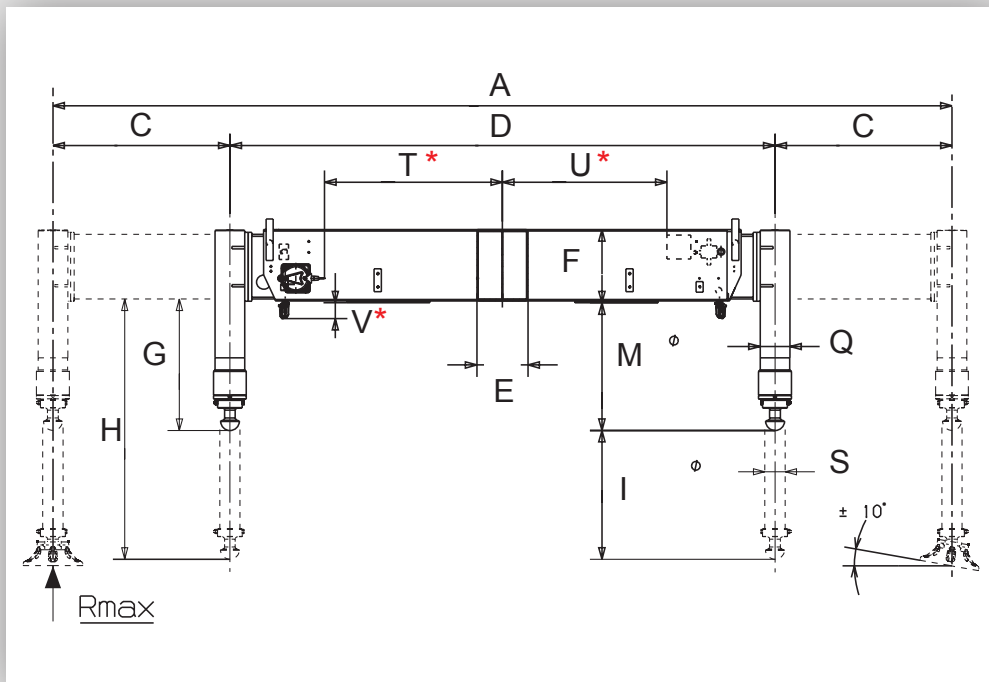

* only available in CE version
 disponibles uniquement pour la version CE
 disponible sólo para la versión CE
 nur in CE-Version
 disponibile solo per la versione CE
 Alleen verkrijgbaar in CE - uitvoering

OPTIONS	A	C	D	E	F	G	H	I	M	Q	S	T*	U*	V*	
	5080	1395	2290	215	308	553	1095	542	537	125	85	748	692	66	530
R	5150	1395	2360	215	308	934	1578	633	918	125	85	748	692	66	580

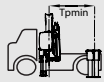

KIT 330K065

F215A.0 - F235A.2	2000 mm
F245A.0 - F275A.2	2500 mm
F295A.2 - F315RA.2	3000 mm
F335A.2 - F365RA.2	3500 mm
F385A.2 - F425RA.2	4000 mm
F415A.2 - F455RA.2	4500 mm

10000 daN

6 kg



SUPPLEMENTARY OUTRIGGERS

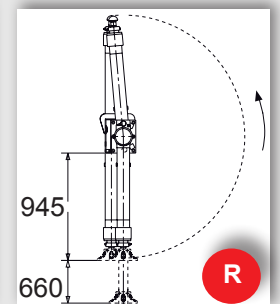
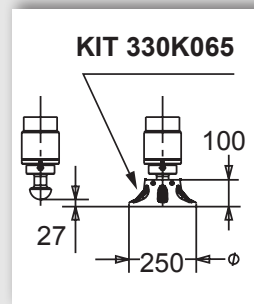
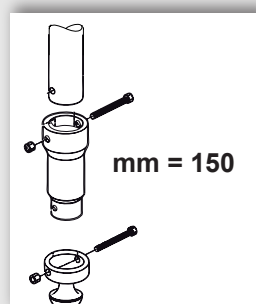
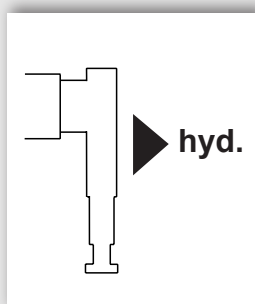
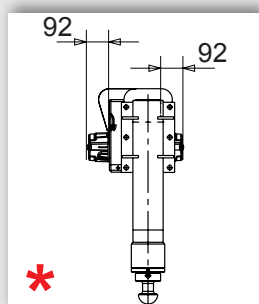

185° SX
 180° DX

optional

290800HE - 290800HE/CE

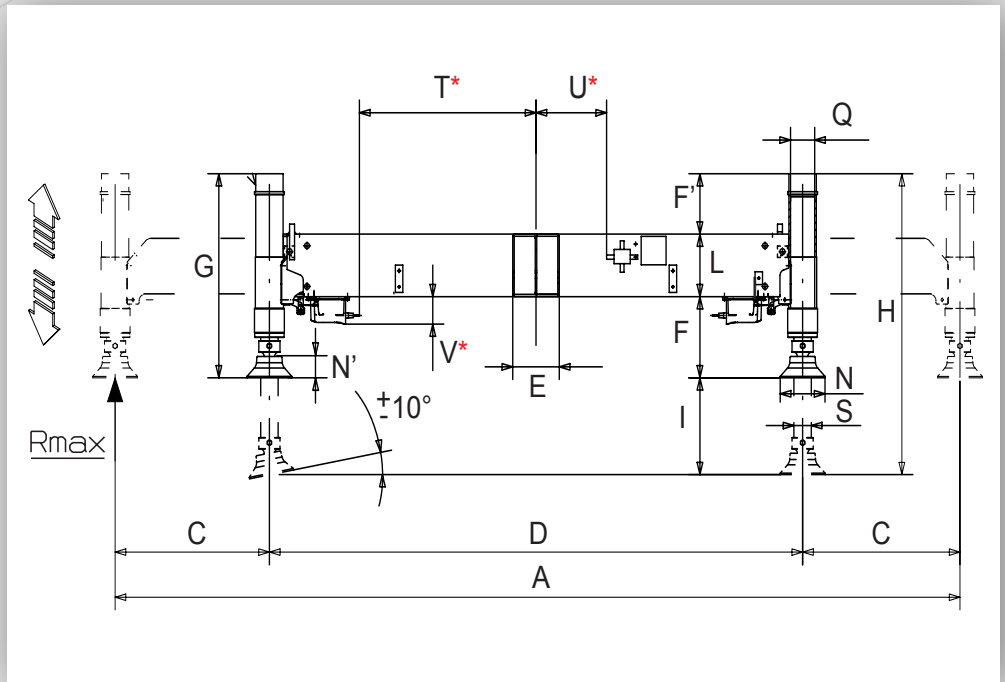

* only available in CE version
 disponibles uniquement pour la version CE
 disponible sólo para la versión CE
 nur in CE-Version
 disponibile solo per la versione CE
 Alleen verkrijgbaar in CE - uitvoering

	A	C	D	E	F'	F	G	H	I	L	N	N'	Q	S	T*	U*	V*	
L	4142	1000	2142	187	-8/438	731/285	943	1493	550	220	180	75	97	70	709	284	96	340
C	4142	1000	2142	187	-8/212	505/285	717	1057	340	220	180	75	97	70	709	284	96	320

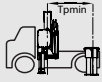

F110A.0 - F135A.2 3000 mm

F155A.0 - F165A.2 3200 mm

F175A.0 - F175A.2 3500 mm

F195A.0 - F195A.2 3850 mm

F215A.0 - F235A.0 3850 mm

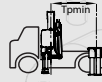

F215A.2 - F235A.2 4000 mm

F245A.0 - F275A.0 4000 mm

F245A.2 - F275A.2 4000 mm

F295A.2 - F315A.2 4200 mm

F295RA.2 - F315RA.2 4200 mm



5710 daN

SUPPLEMENTARY OUTRIGGERS

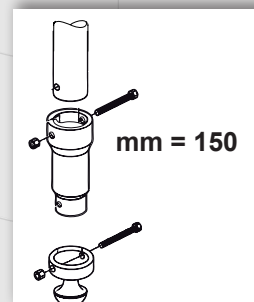
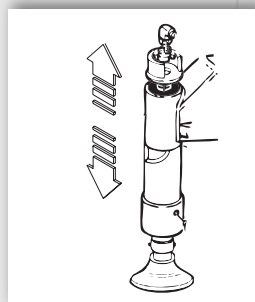
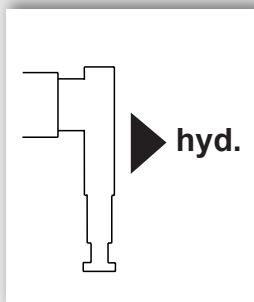

330802HE - 330802HE/CE

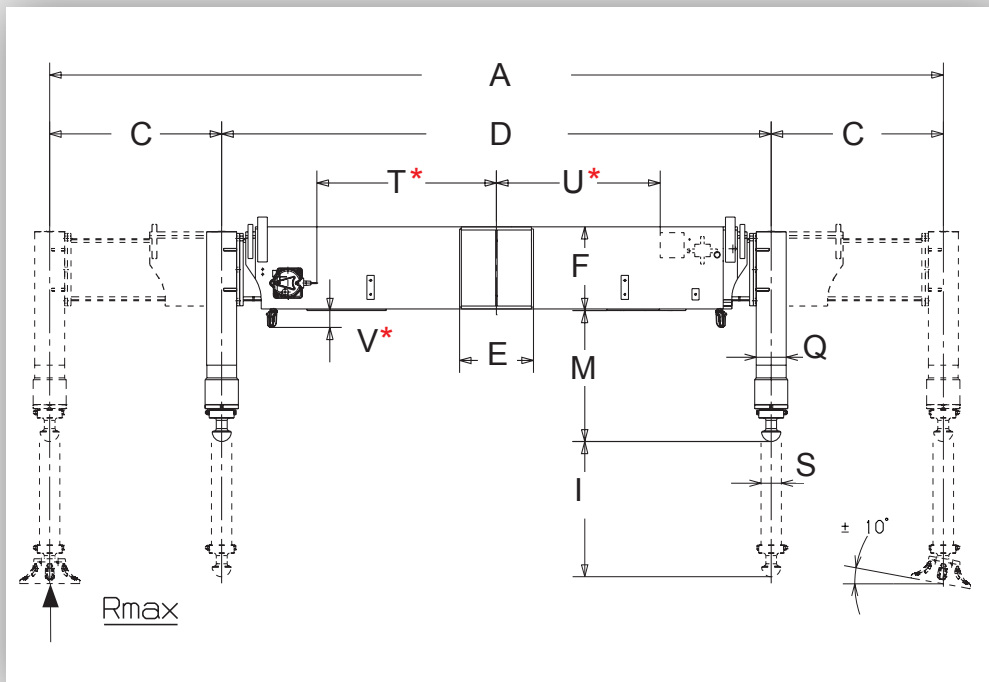

* only available in CE version
 disponibles uniquement pour la version CE
 disponible sólo para la versión CE
 nur in CE-Version
 disponibile solo per la versione CE
 Alleen verkrijgbaar in CE - uitvoering

OPTIONS	A	C	D	E	F	I	M	Q	S	T*	U*	V*	
	5990	1850	2290	256	318	542	537	125	85	735	685	66	720
R	6060	1850	2360	256	318	633	913	125	85	735	685	66	770

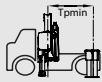

KIT 330K065

F335A.2 - F425RA.2

3000 mm

14000 daN

6 kg

F415RA.2 - F455RA.2

3500 mm

F510RA.2 - F560RA.2

4000 mm

SUPPLEMENTARY OUTRIGGERS

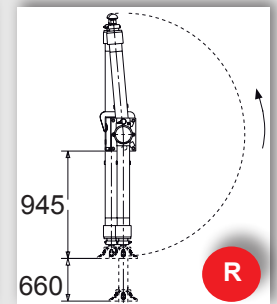
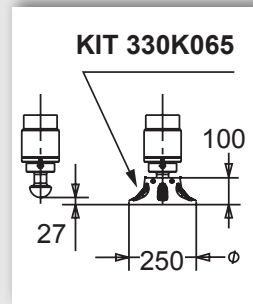
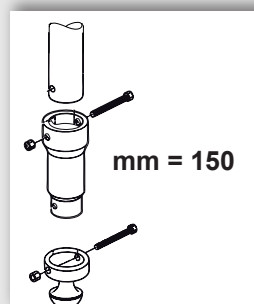
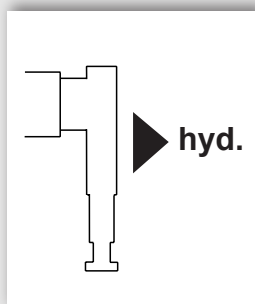
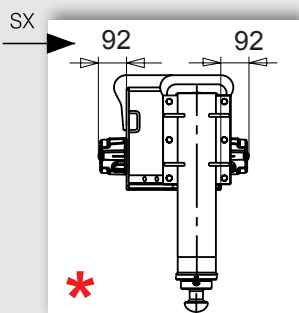

185° SX
 180° DX

optional

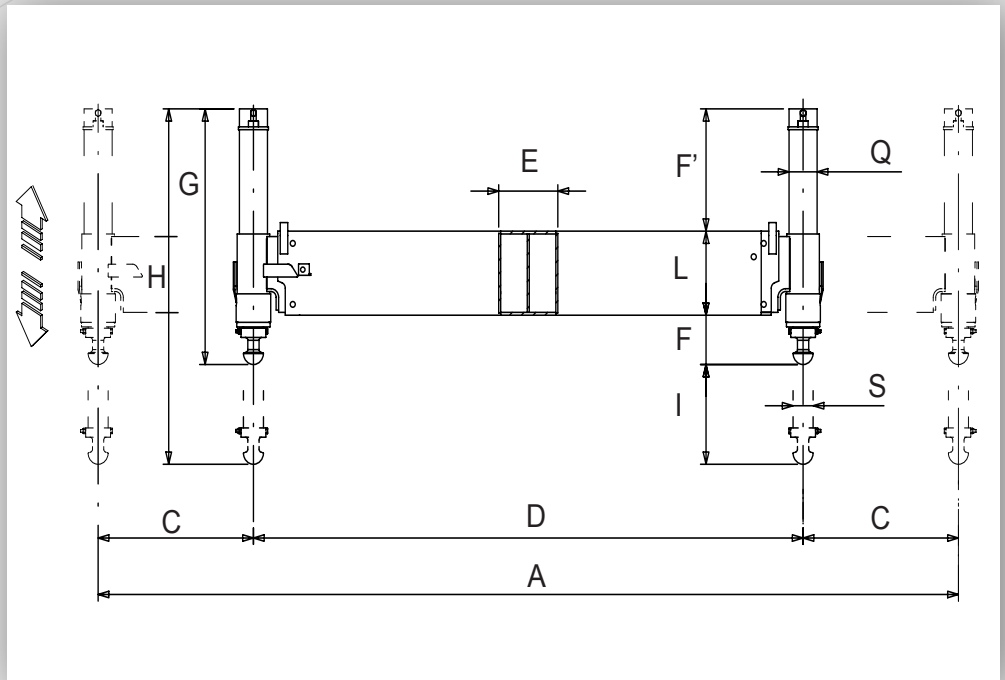

* only available in CE version
 disponibles uniquement pour la version CE
 disponible sólo para la versión CE
 nur in CE-Version
 disponibile solo per la versione CE
 Alleen verkrijgbaar in CE - uitvoering

A	C	D	E	F'	F	G	H	I	L	Q	S	
4984	1395	2194	236	63/429	539/173	897	1417	520	295	112	80	575



F360SE

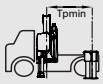

3500 mm

KIT 330K064

14 kg

SUPPLEMENTARY OUTRIGGERS

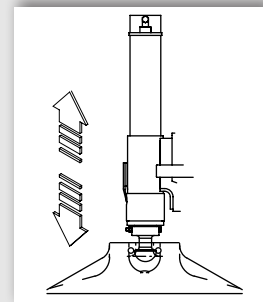
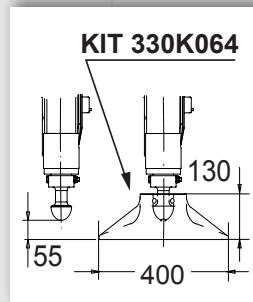
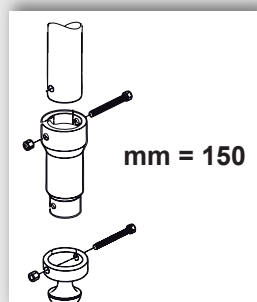
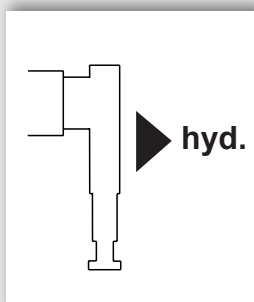

415800HE - 415800HE/CE

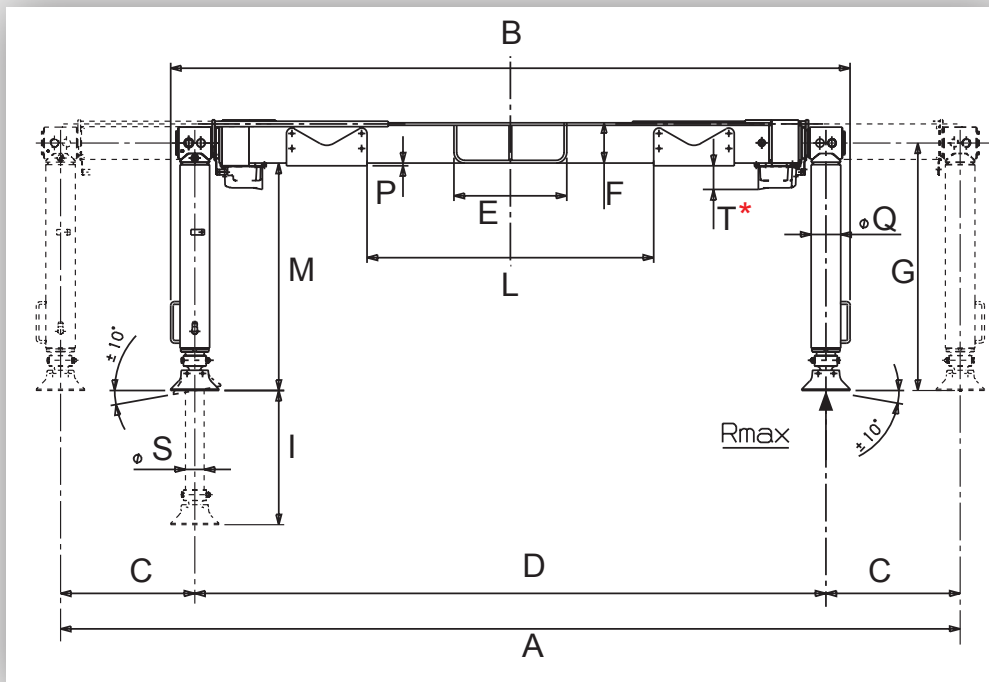

* only available in CE version
 disponibles uniquement pour la version CE
 disponible sólo para la versión CE
 nur in CE-Version
 disponibile solo per la versione CE
 Alleen verkrijgbaar in CE - uitvoering

A	B	C	D	E	F	G	I	L	M	P	Q	S	T*	
5450	2530	1550	2350	420	150	920	550	1067	847	10	110	70	90	660

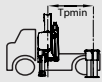

F215A.0 - F275A.2 5000 mm

F295A.2 - F365RA.2 5500 mm

F385A.2 - F455RA.2 6000 mm

9000 daN



SUPPLEMENTARY OUTRIGGERS

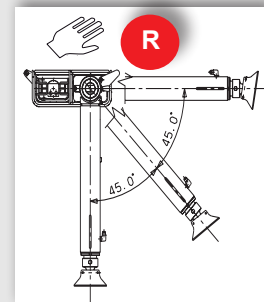
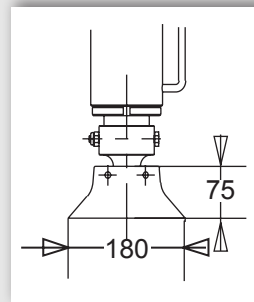
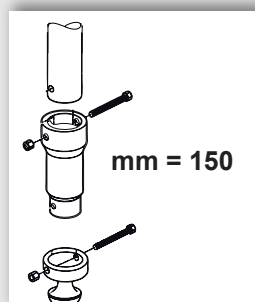
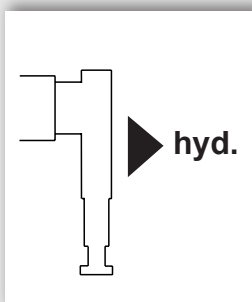

415802HE - 415802HE/CE

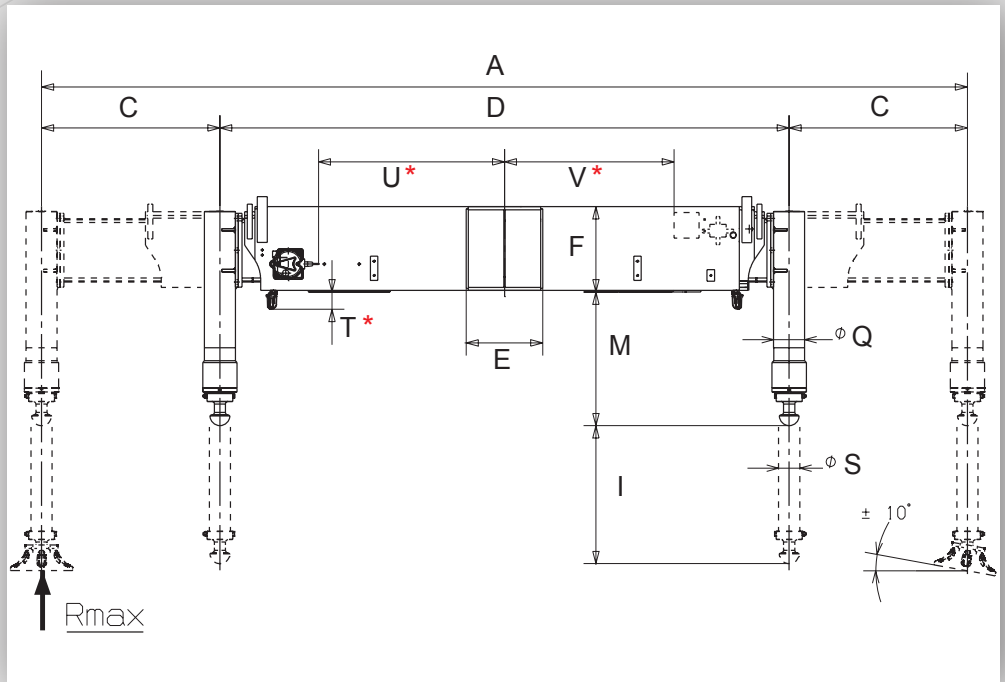

* only available in CE version
 disponibles uniquement pour la version CE
 disponible sólo para la versión CE
 nur in CE-Version
 disponibile solo per la versione CE
 Alleen verkrijgbaar in CE-uitvoering

OPTIONAL	A	C	D	E	F	I	M	Q	S	T*	U*	V*	
	7210	2460	2290	308	335	542	525	125	85	68	750	680	970
R	7280	2460	2360	308	335	648	910	125	85	68	750	680	1040

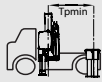

KIT 330K065

6 kg

F385A.2 - F425A.2	3000 mm
F385RA.2 - F425RA.2	3000 mm
F415A.2 - F455A.2	3500 mm
F415RA.2 - F455RA.2	3500 mm
F510RA.2 - F560RA.2	4000 mm
F600RA.2 - F660RA.2	4500 mm

16850 daN

SUPPLEMENTARY OUTRIGGERS

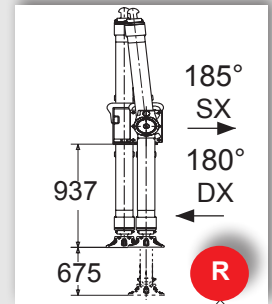
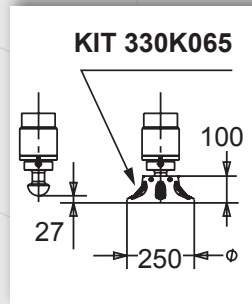
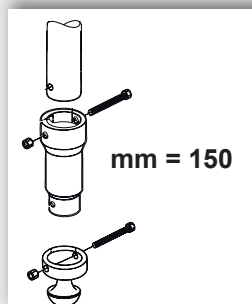
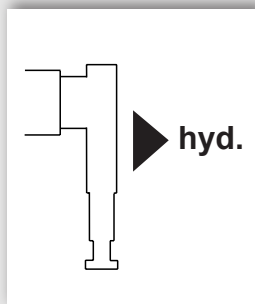
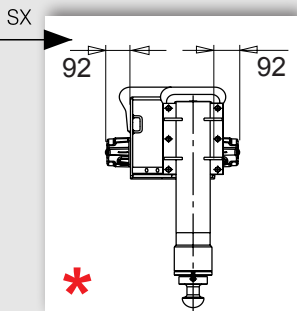

optional

541800HE - 541800HE/CE

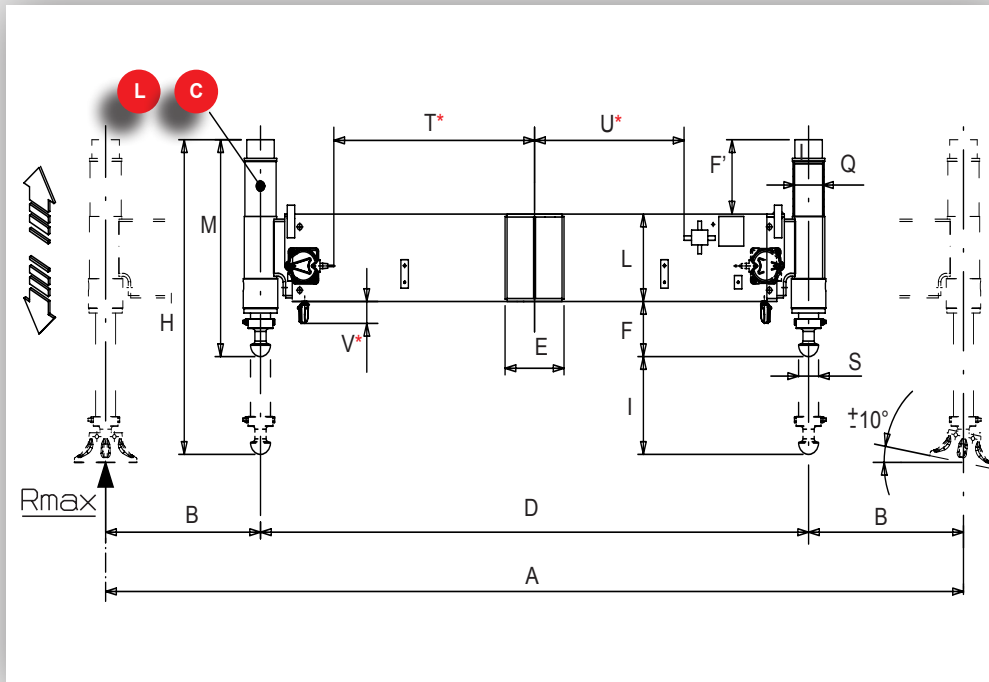

* only available in CE version
 disponibles uniquement pour la version CE
 disponible sólo para la versión CE
 nur in CE-Version
 disponibile solo per la versione CE
 Alleen verkrijgbaar in CE - uitvoering

	A	B	D	E	F'	F	H	I	L	M	Q	S	T*	U*	V*	
L	4984	1395	2194	236	65/416	537/186	1407	510	295	897	112	80	803	600	74	570
C	4984	1395	2194	236	65/251	372/186	1062	330	295	732	112	80	803	600	74	555

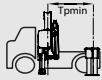

KIT 330K065

F335A.2 - F365A.2 3500 mm

13040 daN

6 kg

F335RA.2 - F365RA.2 3500 mm

F385A.2 - F425A.2 3850 mm

F385RA.2 - F425RA.2 3850 mm

F415A.2 - F455A.2 4000 mm

F415RA.2 - F455RA.2 4000 mm

F510RA.2 - F560RA.2 5300 mm

F600RA.2 - F660RA.2 5800 mm

SUPPLEMENTARY OUTRIGGERS

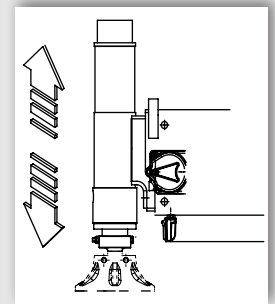
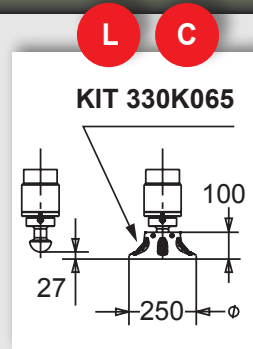
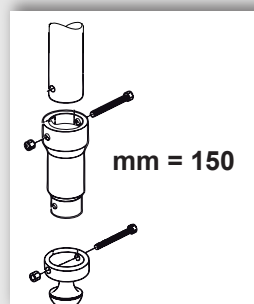
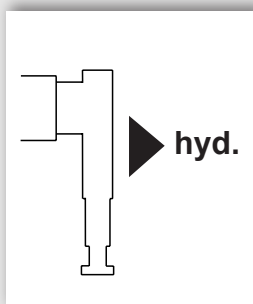
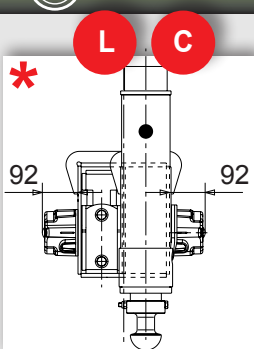

700802HE - 700802HE/CE

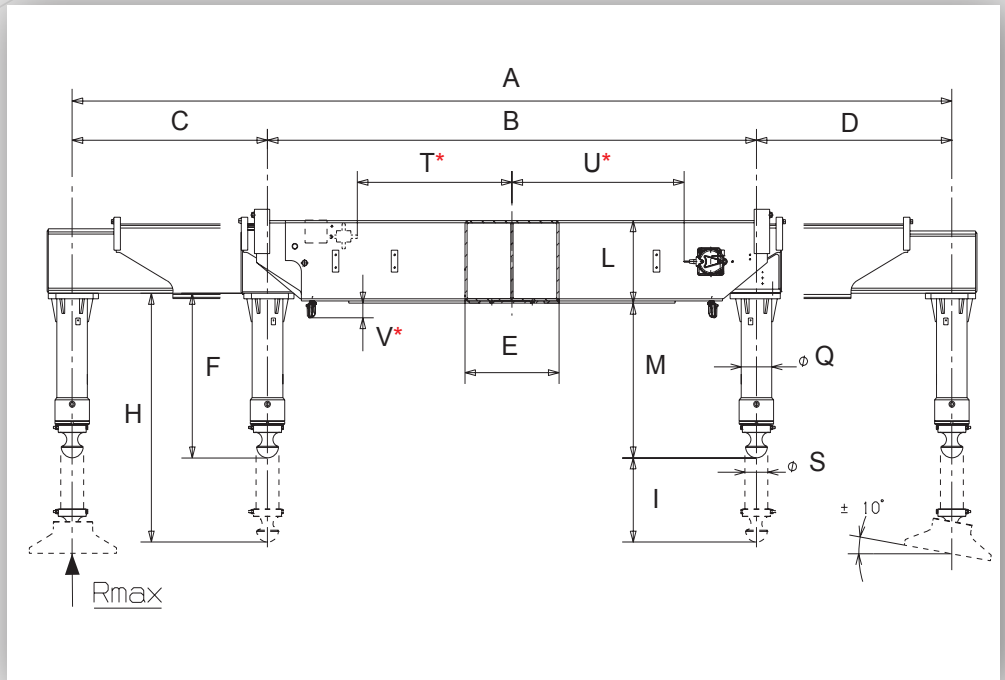

* only available in CE version
 disponibles uniquement pour la version CE
 disponible sólo para la versión CE
 nur in CE-Version
 disponibile solo per la versione CE
 Alleen verkrijgbaar in CE-uitvoering

	A	B	C	D	E	F	H	I	L	M	Q	S	T*	U*	V*	
L	8290	2240	3100	2950	431	725	1095	370	363	680	140	105	709	788	64	1495
C	8290	2240	3100	2950	431	875	1395	520	363	830	140	105	709	788	64	1475

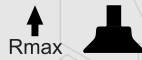
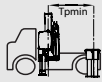

KIT 330K062

16 kg

24500 daN

F600RA.2 - F660RA.2 3000 mm

F700RA.2 - F800RA.2 3500 mm

F950RA.2 4000 mm

F1100RA.2 4500 mm

SUPPLEMENTARY OUTRIGGERS

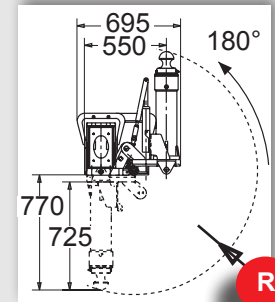
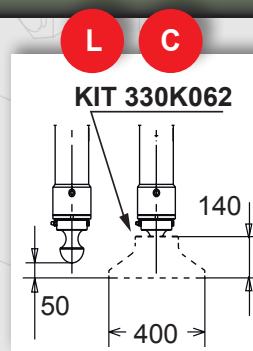
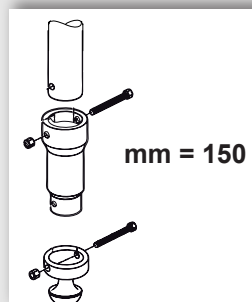
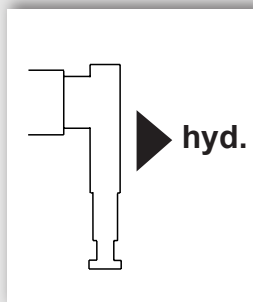
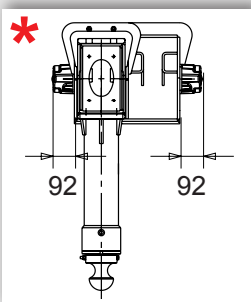

R 830

optional

751801HE - 751801HE/CE

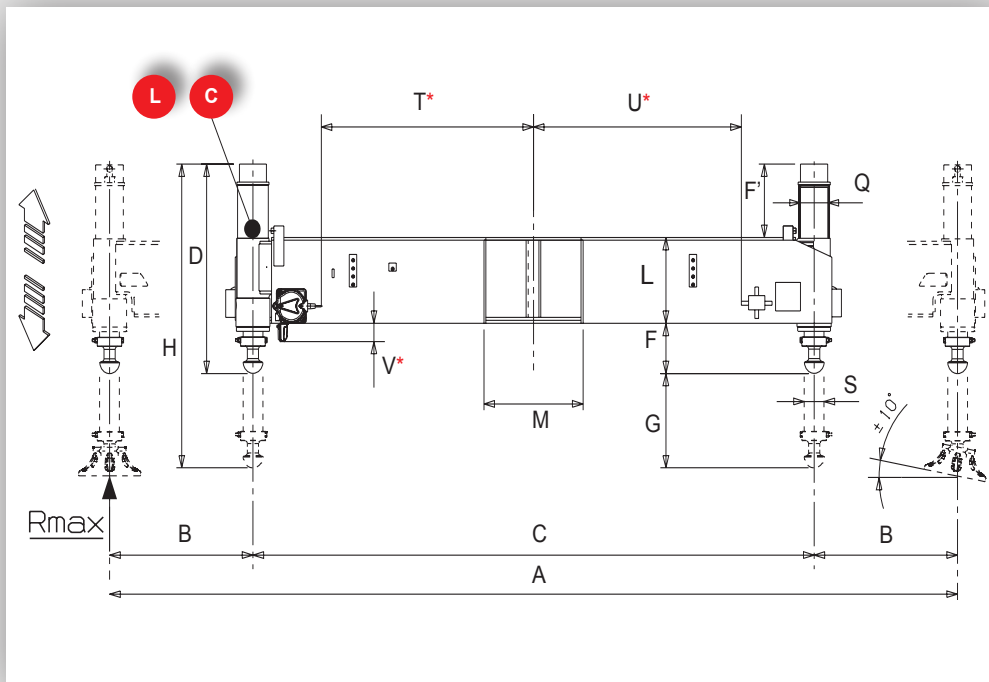

* only available in CE version
 disponibles uniquement pour la version CE
 disponible sólo para la versión CE
 nur in CE-Version
 disponibile solo per la versione CE
 Alleen verkrijgbaar in CE - uitvoering

	A	B	C	D	F'	F	G	H	L	M	Q	S	T*	U*	V*	
L	5770	1750	2270	912	70/436	542/176	510	1422	300	401	112	80	860	840	65	815
C	5770	1750	2270	732	70/256	362/176	330	1062	300	401	112	80	860	840	65	805

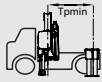

F700RA.2 - F800RA.2 3500 mm



16220 daN

KIT 330K065

6 kg



SUPPLEMENTARY OUTRIGGERS

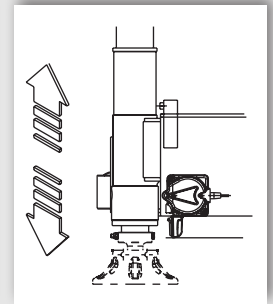
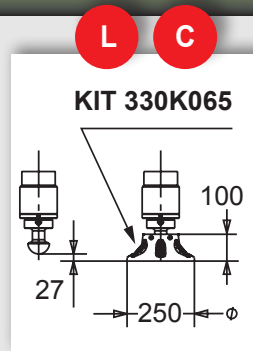
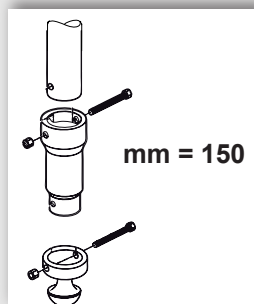
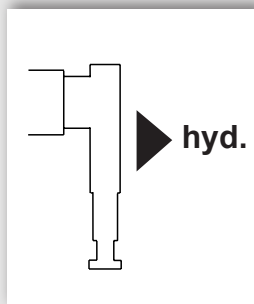
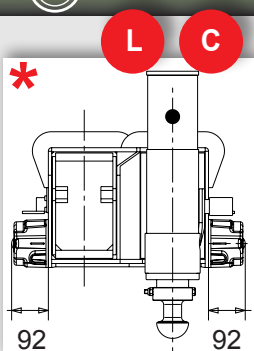

751802HE - 751802HE/CE

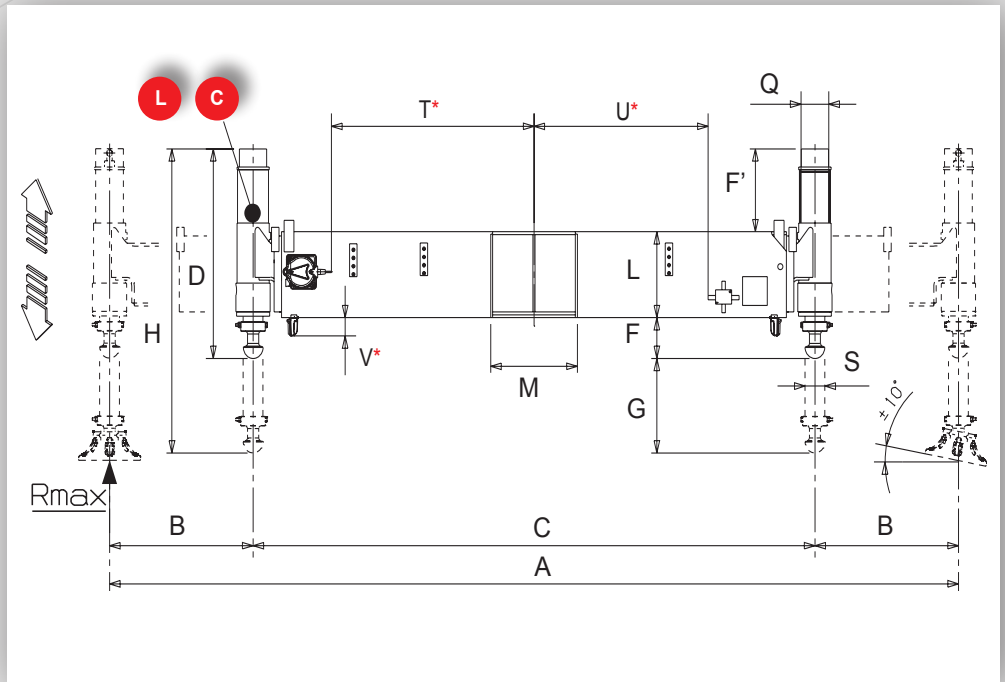

* only available in CE version
 disponibles uniquement pour la version CE
 disponible sólo para la versión CE
 nur in CE-Version
 disponibile solo per la versione CE
 Alleen verkrijgbaar in CE - uitvoering

	A	B	C	D	F'	F	G	H	L	M	Q	S	T*	U*	V*	
L	6870	2300	2270	912	104/470	508/142	510	1422	300	350	112	80	820	705	65	920
C	6870	2300	2270	732	104/290	328/142	330	1062	300	350	112	80	820	705	65	910



F700RA.2 - F800RA.2

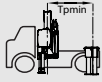

3500 mm



14070 daN

KIT 330K065

6 kg

SUPPLEMENTARY OUTRIGGERS

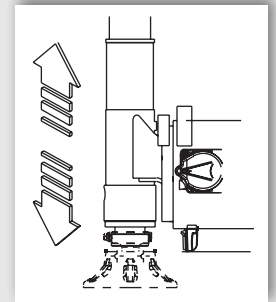
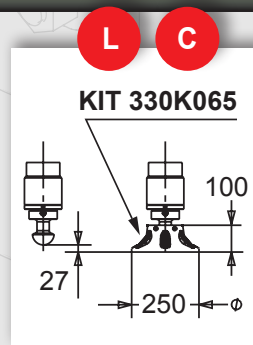
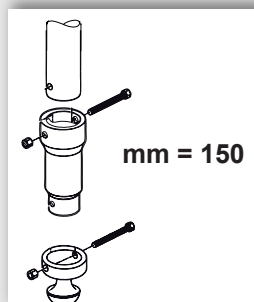
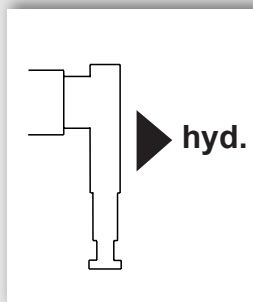
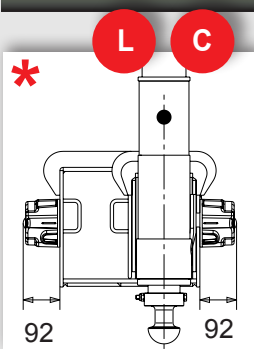

1400A140 - 1400A140/CE

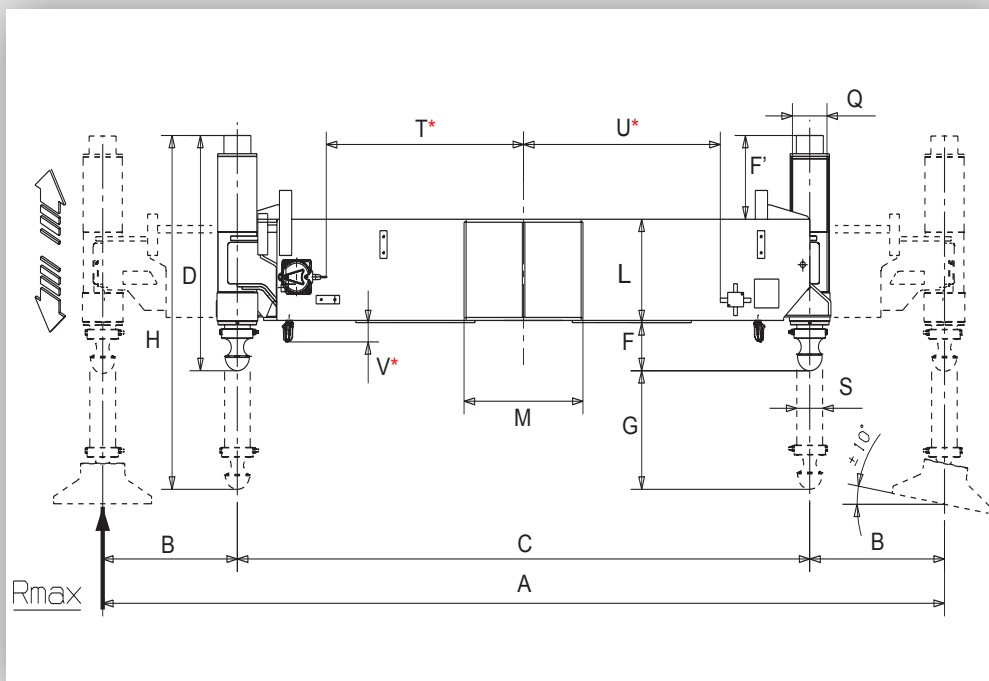

* only available in CE version
 disponibles uniquement pour la version CE
 disponible sólo para la versión CE
 nur in CE-Version
 disponibile solo per la versione CE
 Alleen verkrijgbaar in CE - uitvoering

A	B	C	D	F	F'	G	H	L	M	Q	S	T*	U*	V*	
8538	3100	2338	815	427/167	30/290	410	1225	358	485	140	105	805	805	65	1650

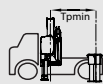

KIT 330K062

F950RA.2 4000 mm

18480 daN

16 kg

F1100RA.2 4000 mm

F1300RA.2 4000 mm

F1500RA.2 4000 mm



SUPPLEMENTARY OUTRIGGERS

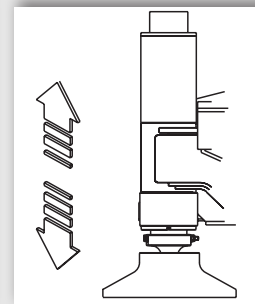
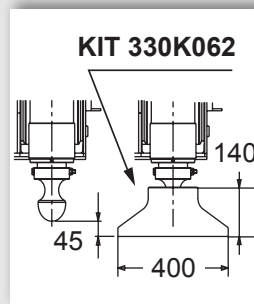
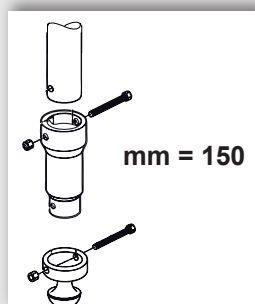
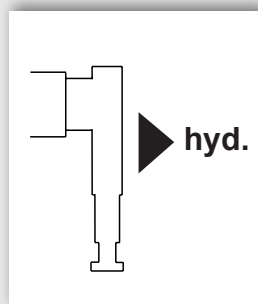
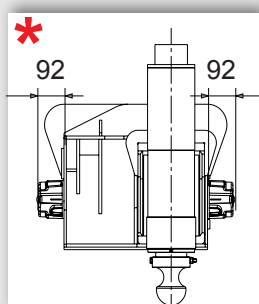

1400A203 - 1400A203/CE

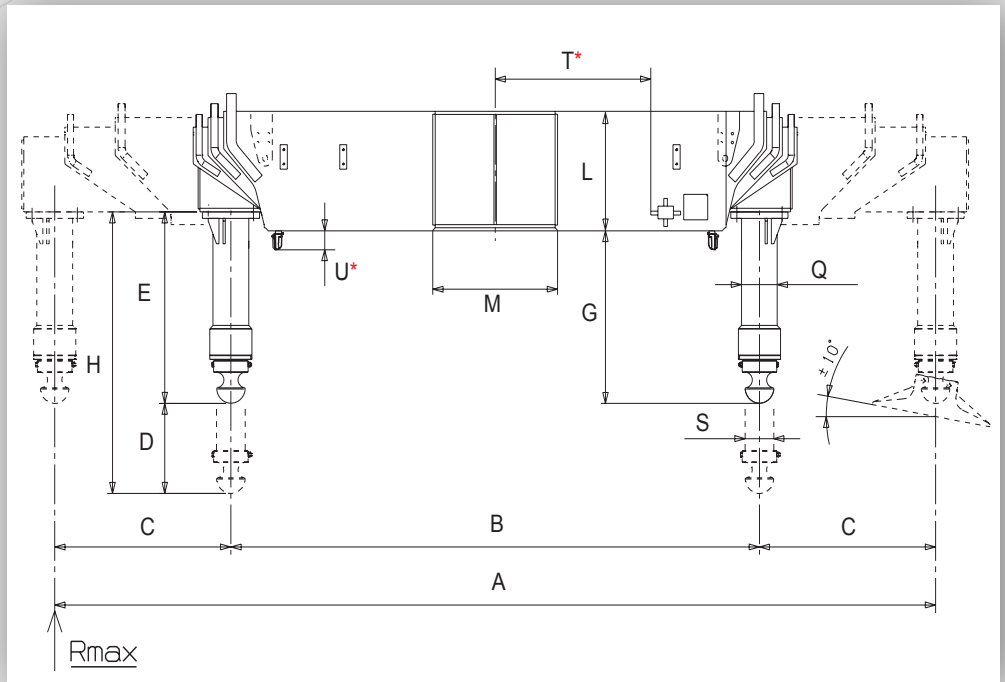

* only available in CE version
 disponibles uniquement pour la version CE
 disponible sólo para la versión CE
 nur in CE-Version
 disponibile solo per la versione CE
 Alleen verkrijgbaar in CE - uitvoering

A	B	C	D	E	G	H	L	M	Q	S	T*	U*	
9960	2220	3870	353	750	676	1103	468	524	150	120	654	74	2450

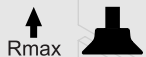
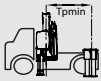

KIT 330K033

F1500RA.2

3900 mm

36500 daN

17 kg

F1950RA.2

4400 mm

SUPPLEMENTARY OUTRIGGERS

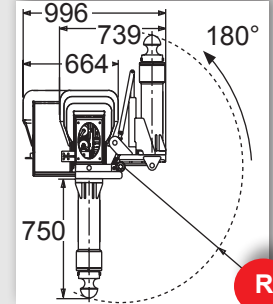
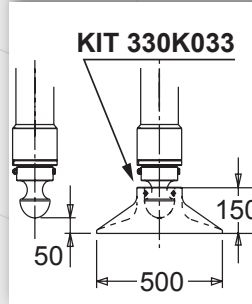
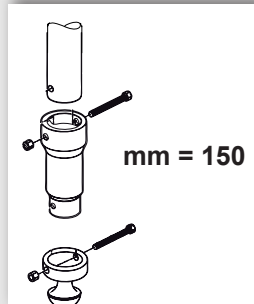
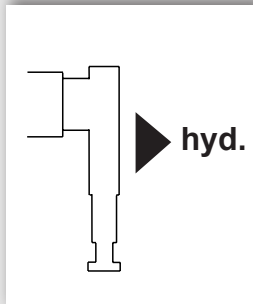
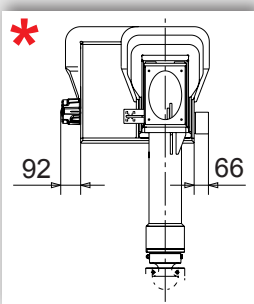

optional

R 854

1400A303 - 1400A303/CE

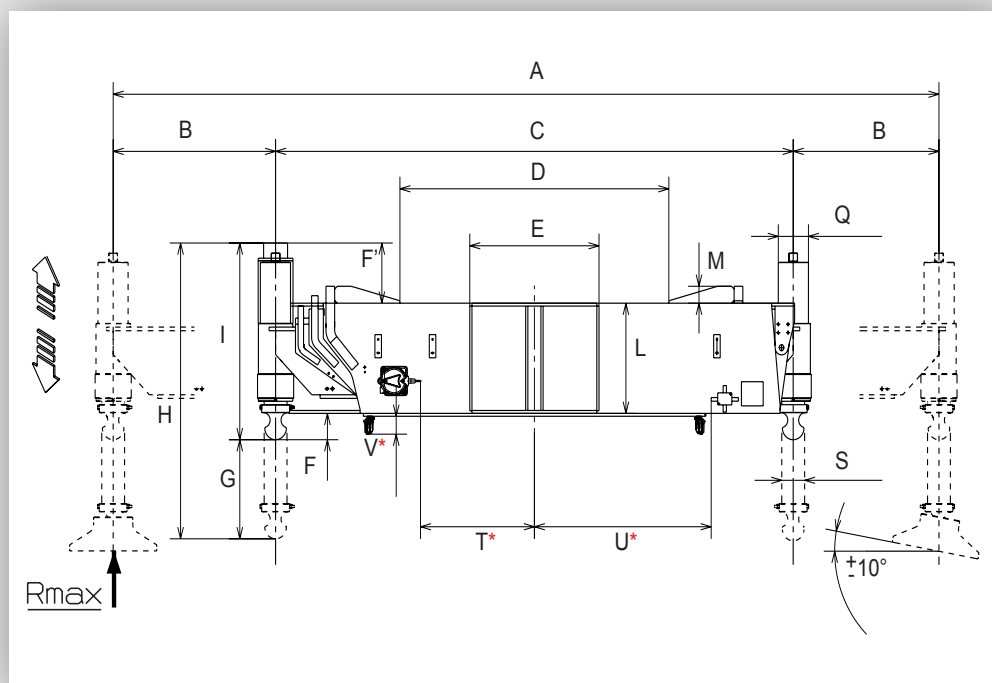

* only available in CE version
 disponibles uniquement pour la version CE
 disponible sólo para la versión CE
 nur in CE-Version
 disponibile solo per la versione CE
 Alleen verkrijgbaar in CE - uitvoering

A	B	C	D	E	F	F'	G	H	I	L	M	Q	S	
10120	3870	2380	1236	594	109/362	249/-4	410	1224	814	456	70	140	105	2420

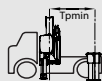

KIT 330K062

F1500RA.2

3900 mm

36500 daN

16 kg

F1950RA.2

4400 mm



SUPPLEMENTARY OUTRIGGERS

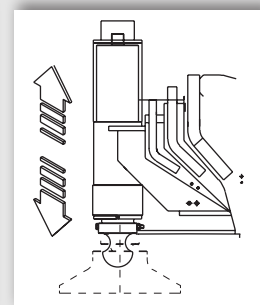
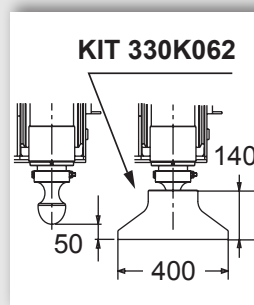
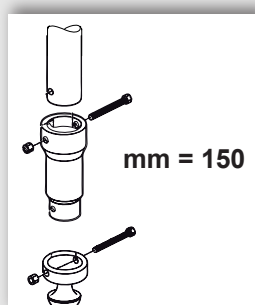
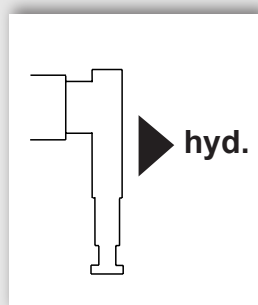
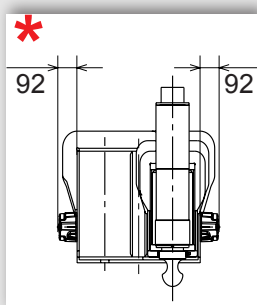

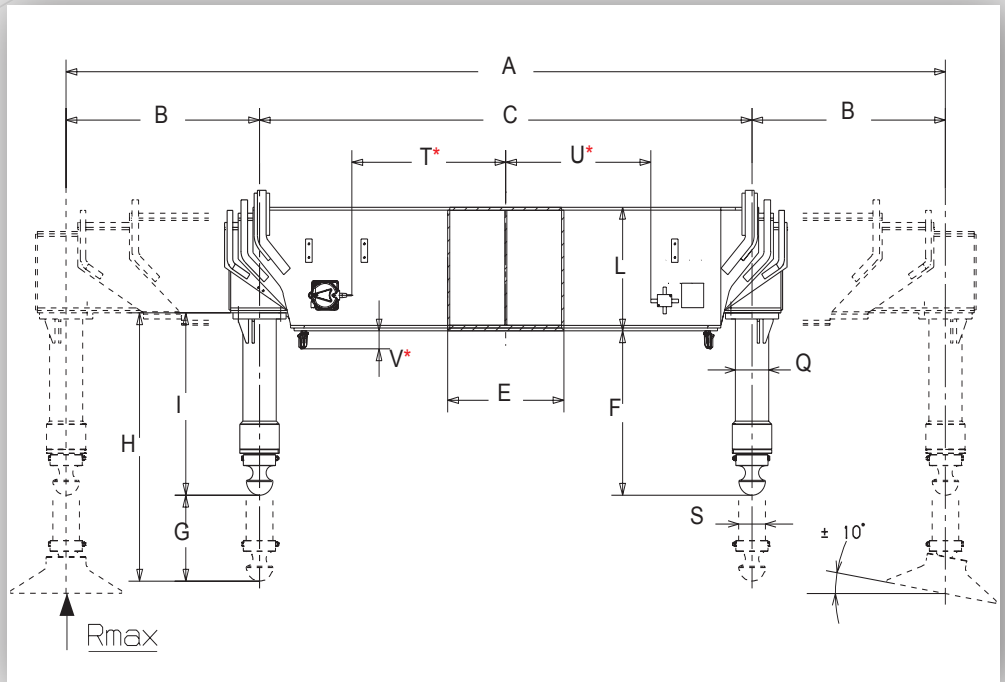

* only available in CE version
 disponibles uniquement pour la version CE
 disponible sólo para la versión CE
 nur in CE-Version
 disponibile solo per la versione CE
 Alleen verkrijgbaar in CE-uitvoering

A	B	C	E	F	G	H	I	L	Q	S	T*	U*	V*	
10990	4385	2220	524	676	353	1103	750	508	150	120	693	654	74	2430



F1950RA.2

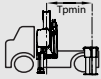

2000 mm



36500 daN

KIT 330K033





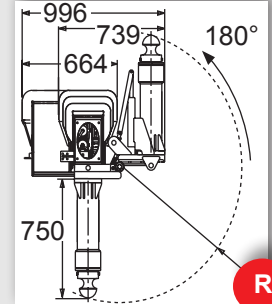
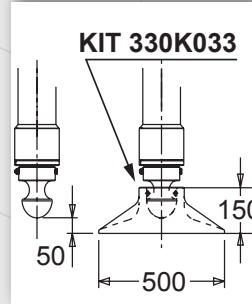
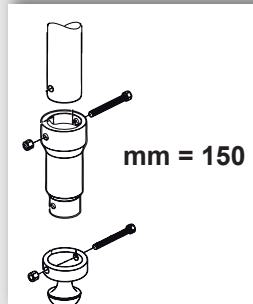
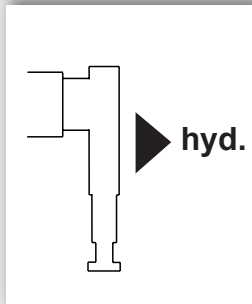
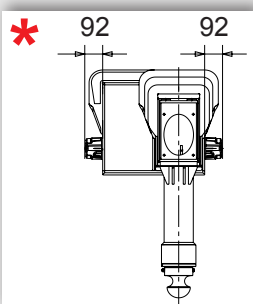









17 kg

SUPPLEMENTARY OUTRIGGERS

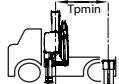
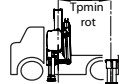

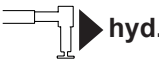
R 854

optional

						
	Reazione massima traversa standard	Maximum reaction of supplementary outrigger	Réaction maximum traverse supplémentaire standard	Höchste Reaktion vom standard Abstützträger	Reacción máxima estabilizador suplementario	Maximale reactiekraft van de standaard afstempelbalk
	Reazione massima traversa con martinetto rotante	Maximum reaction of supplementary outrigger with tiltable ram	Réaction maximum traverse supplémentaire avec vérin pivotant	Höchste Reaktion vom standard Abstützträger mit schwenkbarer Abstützung	Reacción máxima estabilizador suplementario con cilindro orientable	Maximale reactiekraft van de afstempelbalk voorzien van opzwenkbare steunpootcilinders
	Distanza minima tra centro colonna e traversa supplementare	Minimum distance between crane column center and supplementary outrigger	Distance minimum entre le centre colonne grue et la traverse supplémentaire	Minderabstand Kransäule – Zusatzabstützträger	Distancia mínima centro columna de la grúa y centro estabilizador suplementario	Minimale afstand tussen de hartlijn van de kraan en de afstempelbalk
	Distanza minima tra centro colonna e traversa supplementare con martinetto rotante	Minimum distance between crane column center and supplementary outrigger with tiltable ram	Distance minimum entre le centre colonne grue et la traverse supplémentaire avec vérin pivotant	Minderabstand Kransäule – Zusatzabstützträger bei Hochschwenkstützbeinen	Distancia mínima centro columna de la grúa y centro estabilizador suplementario con cilindro orientable	Minimale afstand tussen de hartlijn van de kraan en de afstempelbalk voorzien van opzwenkbare steunpootcilinders
	Peso traversa supplementare	Weight of supplementary outrigger	Poids traverse supplémentaire	Gewicht zusätzlicher Abstützträger	Peso estabilizador suplementario	Eigen gewicht van de afstempelbalk
	Modello Gru	Crane model	Modèle grue	Kranmodell	Modelo grúa	Kraanmodel
	Estensione Manuale	Manual extension	Extension Manuelle	Manuelle Verlängerung	Extensión manual	Handmatig uitschuifbaar
	Estensione Idraulica	Hydraulic extension	Extension hydraulique	Hydraulische Verlängerung	Extensión hidráulica	Hydraulisch uitschuifbaar
	Rotante	Tiltable	Pivotant	Schwenkbar	Orientable	Opzwenkbaar
	Lungo	Long	Long	Lang	Largo	Lang
	Corto	Short	Court	Kurz	Corto	Kort

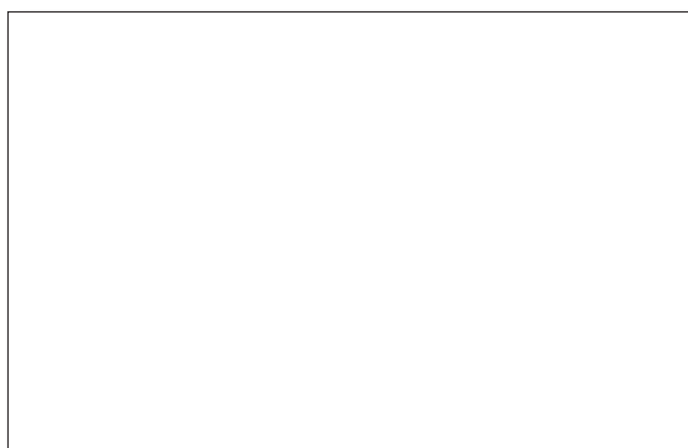

FASSI

www.fassi.com

FASSI GRU S.p.A.
Via Roma, 110
24021 Albino (Bergamo) ITALY
Tel- +39 035 776400
Fax +39 035 755020
<http://www.fassi.com>
E-mail: fassi@fassi.com

COMPANY
WITH QUALITY MANAGEMENT
SYSTEM CERTIFIED BY DNV
=ISO 9001:2008=